

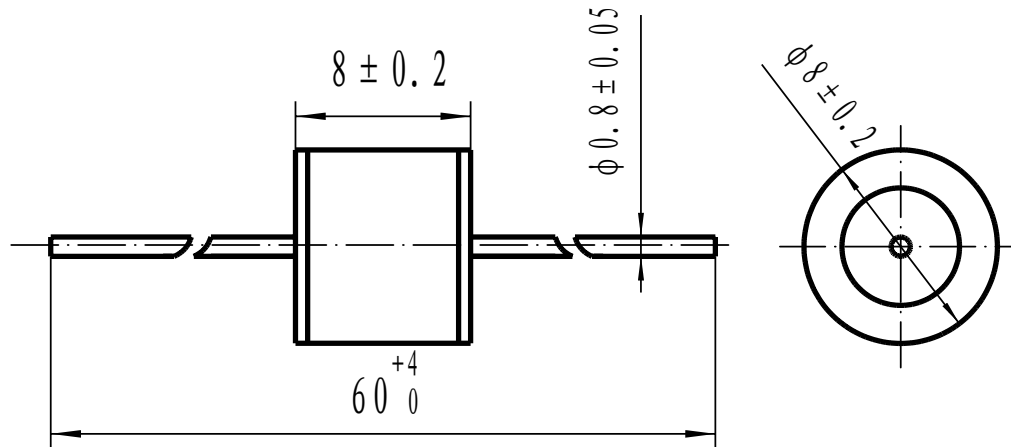

杭州东沃电子科技有限公司  
HangZhou DongWo Electronic Technology Co., Ltd.  
Specification of Gas discharge Tube

Part No.:2R1500AI-0 (Φ8×8)

一、外形尺寸/DIMENSION (Unit:mm, Scale:3:1)



二、电性能参数/ELECTRICAL CHARACTERISTICS  
(terms in accordance with ITU-T K.12)

1、标称直流击穿电压 (Vs) Nom. DC spark-over voltage	1500V
2、直流击穿电压范围 (100V/s) Tolerance of Vs	1200V ~ 1800V
3、冲击击穿电压 (100V/μs) Impulse spark-over voltage	≤ 2200V
4、耐脉冲冲击电流 (8/20 μs) Impulse discharge current	3kA
5、标称耐工频电流 (50Hz) Nom. alternating discharge current	1A
6、绝缘电阻 (DC100V) Insulation resistance	≥ 10GΩ
7、极间电容(1MHz) Capacitance	≤ 1pF
8、工作贮存温度 Operation and storage temperature	-40 ~ 90℃
9、气候类型 Climatic category(IEC 60068-1)	40/90/21
10、无放射性 Without Radioactivity	

三、包装信息(2R) Package Information

- 1、数量 Quantity: 100pcs/plastic box,4000pcs/carton
- 2、尺寸 Measurement: Plastic box:243\*166\*12mm,  
Carton: 345\*255\*200mm

四、证书

Certificates

ISO9001:2000



E304047 E226846



SGS