

陶瓷放电管三极管

一、外形尺寸

Ø 8.6 x 11.2

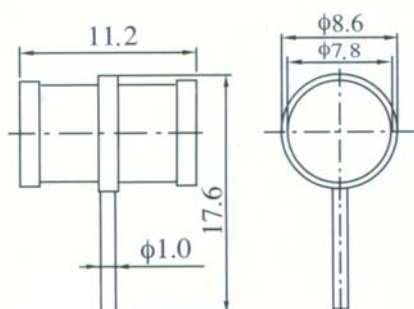

二、电性能参数

1.标称直流击穿电压	(100V/s)	150V
2.直流击穿电压范围	(100V/s)	±25%
3.冲击击穿电压	(100V/μs)	600V
	(1kV/μs)	700V
4.耐脉冲冲击电流	(8/20μs,10 times)	10kA
5.耐脉冲冲击电流	(10/1000μs,300 times)	100A
6.标称耐工频电流	(50Hz,1s,5 times)	10A
7.绝缘电阻	(DC100V)	≥1GΩ
8.极间电容	(1MHz)	≤1.5PF
9.横向电压延迟时间		≤200ns